

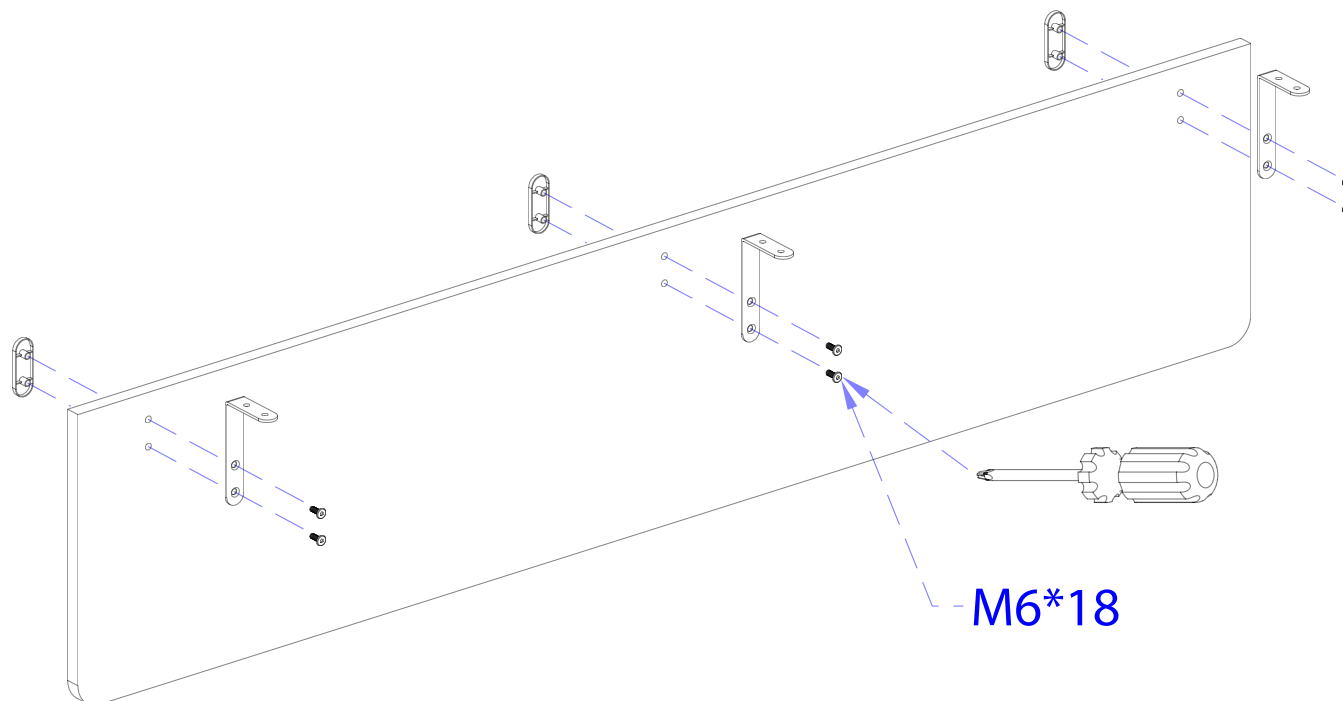



STEP 1



NO.	PICTURE	SIZE/QTY
A		6:M6*18
B		6:ST4*20
C		3:PJ-15
D		3:PJ-16

STEP 2

